

the GEC Journal of Research

Incorporating the Marconi Review

SPECIAL ISSUE ON RADAR

	Page
Foreword	69
Technology Trends in the First Fifty Years G. D. Speake	
CH—The First Operational Radar B. T. Neale	
Microwaves	
	92
	104
	114
The ERS-1 Synthetic Aperture Radar and Scatterometer S. R. Brooks, H. Joyce, F. G. Sawyer and D. J. Smith	124
Whither Radar? M. F. Radford	137
Contributors to this Issue	144

CH—The First Operational Radar
B. T. Neale

CH - THE FIRST OPERATIONAL RADAR

B. T. NEALE

The CH (Chain Home) radar was the first to be organized into a complete defence system, and the first to be used in wartime operations. This paper describes its construction and performance. It had a very long range against high-flying targets, could measure height, and was well-equipped to deal with likely enemy counter-measures.

INTRODUCTION

Fifty years ago on February 26, 1935, a simple experiment in a field near Daventry conclusively demonstrated that aircraft could be detected by radio. The experiment arose directly from the need to prove, to a first order, calculations that suggested that if an aircraft was 'illuminated' by radio waves, enough energy should be 'reflected' to permit detection on the ground by a sensitive receiver. The story of this significant experiment and its immediate consequences has been told many times and is well documented.

It is sufficient to record here that it led to a massive programme, backed by the highest priority and virtually unlimited finance, to design, build and install a chain of early warning systems around the coast of Britain. The importance of this courageous decision to a country whose only early warning of air attack was, at that time, a huge concrete acoustic mirror on the Romney marshes, cannot be over stated. Key stations in the south east of England were operational and integrated into a vast reporting network just in time for the air battles to come.

The purpose of this article is to describe in some detail the principal component of this remarkable system: The 'CH' station (AMES Type 1), the direct descendant of the 'Daventry Experiment'.

GENERAL PRINCIPLE

The basic operating principle of CH is very simple: the volume of sky to be kept under surveillance is literally 'floodlit' with r.f. pulsed energy; the back-

scattered pulses or 'echoes' from all aircraft within this volume are received back at the ground station by a set of crossed-dipoles connected to a low-noise, high-gain receiver and displayed as a Y-deflection along the time base of a CRT. The aircraft range is simply a precise measurement of the elapsed time between the transmitted pulse and the 'echo', and the bearing a measurement of the ratio of 'echo' strengths of the X- and Y-components of the crossed-dipoles. These principles are illustrated in figure 1.

Choice of frequency, polarization and p.r.f.

The choice of radio frequency was principally influenced by three factors: the 'state of the art' technology in 1935, feasible antenna dimensions to provide the vertical polar diagram and antenna gain required for efficient floodlighting and heightfinding; and a wavelength that was considered at that time likely to give the best 'echo' from a typical bomber of the period. Very little, if anything, was known at that time about the effective back-scattering cross-section of an aircraft or how it varied with frequency.

It was earlier thought that an approaching aircraft could be regarded as a half-wave, horizontally polarized dipole; in fact, a typical enemy bomber of that period, a Heinkel 111 with a wingspan of 22.5 metres, closely matched the original 'Daventry Experiment' frequency of 6 MHz. This theory was later abandoned.

The original plan was for each station to have the choice of operating on any of four allocated spot

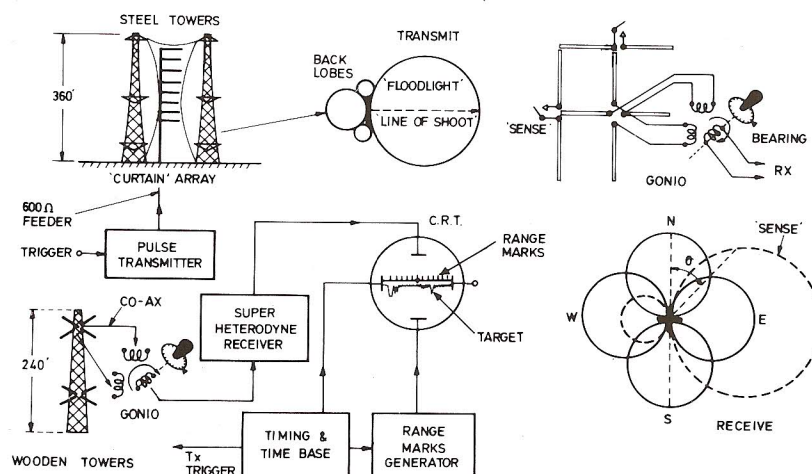

Fig. 1. Principles of CH (Chain Home) R.D.F. system

frequencies in the band 20 to 55 MHz as a counter-measure to possible jamming and as alternative frequencies should interference or propagation effects cause operational problems.

For that purpose, four transmitter and four receiver towers were provided, each pair of towers being dedicated to one spot frequency. It was later decided to abandon the four frequency plan and to have simply a main and standby in the frequency band 20-30 MHz.

All CH Stations used horizontally polarized radiation. The decision to use horizontal rather than vertical was based mainly on three factors:-

1. An approaching aircraft has a predominantly horizontal aspect, favouring – for metric wavelengths – a horizontally polarized wavefront.
2. The signal phase change of π radians on reflection from the ground is constant for all relevant angles of elevation; this is particularly important for the formation of the vertical polar diagram required for heightfinding.
3. A horizontally polarized antenna is inherently symmetrical with respect to ground, permitting balanced, open-wire transmission lines capable of withstanding very high peak voltages to be used without undue complication. Also the symmetrical nature of the antenna simplifies both its design and installation.

OUTLINE DESCRIPTION OF TYPICAL 'EAST COAST' STATION

At the end of World War 2, there were approximately fifty early warning CH Stations (AMES Type 1), of which there were a number of variants, either in 24 hour operation or at standby around the coast of Britain. All used the same basic 'floodlighting/DF' principle but configured differently depending on their operational role; some were 'all-round-looking', there were a number of buried reserves to back up the Chain should the main station be disrupted by enemy action, the West-Coast Chain used different antennae masts and transmitters to the East-Coast; and there were variations in the siting arrangements.

The CH described here is a typical East-Coast version, figure 2, of the type familiar to most people because of the distinctive and massive appearance of the antennae masts, and the vital role it played in winning the Battle of Britain. Of the fifty CH Stations in Britain, twenty one were basically of this type and were installed along the East and South-East coast from Ventnor in the Isle of Wight to Netherbutton in the Orkneys. (See Appendix 1 for complete list).

Each station employed four (later stations were reduced to three) in-line, 360 feet steel transmitter towers spaced approx 180 feet apart, each tower being fitted with cantilevered platforms at 50, 200 and 350 feet. The transmitter 'curtains' were slung between towers and fed by strained 600 Ω transmission lines leading from the heavily protected transmitter building nearby. Two identical trans-

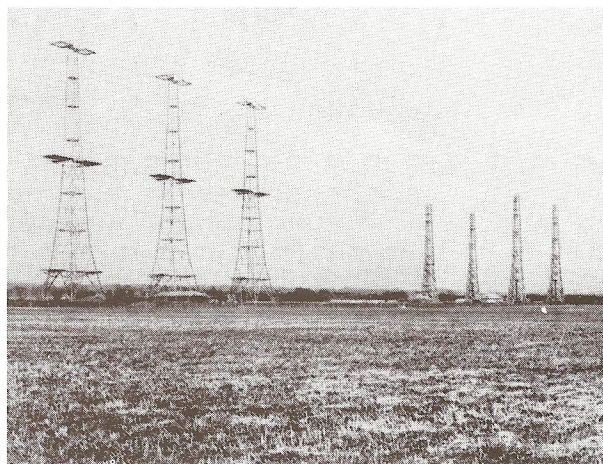

Fig. 2. Typical East Coast CH station

mitters (Type T.3026) were used in a main and standby role, with rapid change-over arrangements in the event of failure of the operational transmitter.

Typical operating conditions were:-

Frequency:	20 to 30 MHz
Peak Power:	350 kW (later 750 kW)
p.r.f.:	25 and 12.5 p.p.s.
Pulse Length:	20 μ s

Four 240 feet wooden receiver towers, usually placed in rhombic formation, carried the receiver arrays. These towers and the associated receiver building were some hundreds of yards from the transmitter buildings and in some cases, were in a separate compound; truly bistatic in fact!

The low p.r.f. of 25 p.p.s. was determined by the need for a long interpulse period to minimize the effect of long range 'scatter' (or clutter) being returned via the ionosphere as 'second, third or fourth time round' signals cluttering the display and masking the area under surveillance. A further requirement was the need to synchronize all CH Stations to the National Grid system to avoid mutual interference (known as 'running rabbits'). A sub-multiple of 50 Hz was therefore essential, plus the need for a long interpulse period to allow sufficient time space (40 ms) for adjacent stations to be allocated time slots which did not overlap. When ionospheric 'scatter' conditions were severe, the operator had a choice of an alternative p.r.f. of 12.5 p.p.s., thereby increasing the interpulse period to 80 ms and extending the immunity range of the 'scatter' to over 6000 miles.

TRANSMITTER ANTENNAE SYSTEM

To provide the necessary 'floodlighting' the transmitter main array consisted of a vertical stack of eight half-wave dipoles. The dipoles were spaced by a half-wavelength and end-fed by an open wire transmission line with alternate feed points transposed to preserve in-phase excitation of the stack, figure 3a. Associated with each dipole was a 'tuned' reflector spaced by 0.18λ . The mean height of the array was 215 feet,

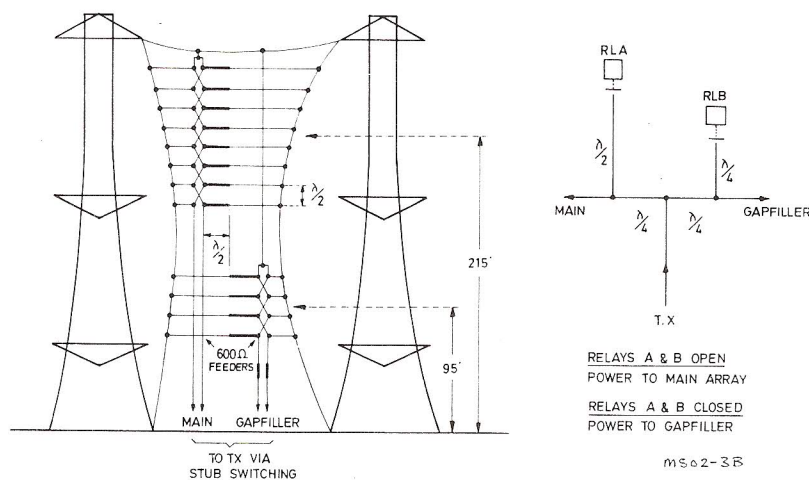

Fig. 3. (a) CH transmitter array (b) stub switching

which produced a main elevation lobe resulting from ground reflection at about 2.6° , and a first gap at 5.2° . The horizontal 'beamwidth' of the dipole stack, influenced by the 0.18λ -spaced reflectors, was in the order of 100° .

To fill the first gap, an auxiliary stack of four similar end-fed dipoles and reflectors was provided at a mean height of 95 feet producing a main elevation lobe at about 6° . This auxiliary array, known as the 'Gapfiller', was selected remotely by the operator, the change over from main array to gapfiller being made by relay-operated stub switching of the transmission line, figure 3b.

Both the eight-stack and the four-stack arrays were slung on the same centre line as a 'curtain' between the cantilevers of two of the four 360 feet steel towers. R.f. power from the transmitter was fed to the curtain by a 600 ohm, open-wire, balanced transmission line and stub matched to the array. The four-stack array was matched to the transmission line by a quarter-wave transformer of suitable impedance slung in the transmission line to the four-stack. As the system was not a true 'floodlight' because of the directional characteristics of the dipole stack and the suppression of the unnecessary back radiation by reflectors, each station was allocated a 'line-of-shoot' (LOS), which determined the alignment of the antenna with respect to the coastline.

THE RECEIVING SYSTEM

The simplified block diagram shown in figure 1 illustrates the operating principles: r.f. pulses 'back scattered' from all aircraft in the 'floodlit' zone are received by a set of crossed horizontal dipoles positioned at an effective height of 215 feet above the ground.

The output of the E-W dipole (Y) is fed to one of the stator coils of the goniometer and that of the N-S (X) dipole to the other. The signals are compared by 'swinging the gonio' for a minimum deflection of the 'echo' on the CRT display. A minimum rather than maximum was used as it gave a sharper and more precise indication of azimuth when the

signal-to-noise ratio was adequate, the gonio bearing 'rose' being aligned accordingly. For weak signals, of poor signal-to-noise ratio, the gonio was swung for a maximum, and the indicated bearing corrected by 90° .

With this method of direction finding (D/F), an aircraft on a reciprocal bearing would give exactly the same indication on the gonio. This ambiguity was resolved by having remotely switchable reflectors $\lambda/4$ behind the dipoles and noting whether the signal strength increased or decreased when they were switched in. This 'sensing' was done by the operator at the console before passing a plot.

The effective height of the crossed dipole stack was 215 feet which, on a flat site, would give rise to a wide vertical gap in the polar diagram centred at an elevation angle α of approximately 5.2° ; the radar would, therefore be blind at this elevation. This was overcome by having a second crossed-dipole stack at a mean height of 95 feet with a main elevation lobe of approximately 5.9° which, in conjunction with the transmitter 'gapfilling' lobe, effectively closed the gap, the switching being done remotely by the operator at the console whilst searching for, and tracking, targets.

Heightfinding was achieved by comparing the signal received by the 215 feet dipole stack ($\alpha = 2.6^\circ$) with the signal received from the same aircraft by the 95 feet ($\alpha = 5.9^\circ$) stack, the ratio of these two signal strengths being related to the angle of elevation of the aircraft, see figures 4 and 5. The ratio of the signal strengths is measured by feeding the signals received by the Y dipoles of the A system at 215 feet to the Y coil of the goniometer and the signals received by the Y dipoles of the B system at 95 feet to the X coil of the goniometer, see figure 4. The goniometer was then 'swung' for a minimum deflection of the 'echo' on the CRT in exactly the same way that the azimuth angle (D/F) was determined in the direction finding mode. The number indicated by the goniometer pointer was then 'inputted' to a simple electro-mechanical computer known as the 'fruit machine' which also accepted the range of the target and performed the simple calculation: height

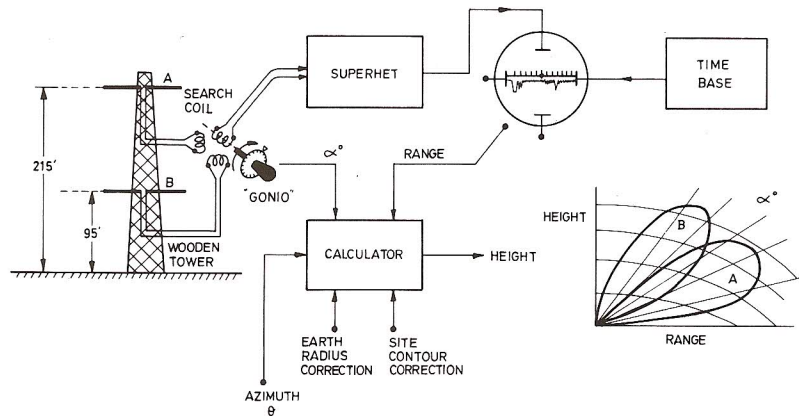

Fig. 4. The principles of CH height-finding

(in feet) = $5280 (R \sin \alpha + R^2/10000)$. The $R^2/10000$ term corrects for earth curvature, assuming an effective earth's radius equal to four thirds of the true radius.

Since heightfinding relied on measurement of the ratio of signal strengths received by lobes created by the ground interference pattern, the ground in front of the antennae should, ideally have been flat out to a range of about one mile. A flat site, when account was taken of all other essential requirements, (see appendix 2) clearly was not achievable for all locations around the coast of UK, and compromises had to be made.

After installation, phasing and alignment of the instrumentation on the ground, a large number of calibration flights were carried out using an auto-gyro making circular and radial tracks at fixed heights. The deviations from the actual to the indicated heights were carefully noted and correction factors calculated for all azimuthal angles within the operational sector centred on the station's 'line-of-shoot.'

These correction factors were 'hard-wired' into the calculator ('fruit machine') by linking the contacts of banks of Post Office type 'Uniselectors' in a manner which took account of the azimuth at which the height was being measured and making the appropriate correction. The calculator therefore received, in addition to the elevation angle from the gonio and range from the A scan of the CRT, the azimuth noted from the original D/F of the aircraft.

At higher elevation angles (α above 8°), there was some ambiguity because of confusion with the multiple upper lobes of the 215 feet dipole stack, but these could be quickly resolved by a skilled operator noting the results of a series of readings. In fact, almost all aircraft of interest ('hostiles') were first observed at long ranges and therefore low angles of elevation, so this problem did not often arise.

For aircraft in the first elevation gap, heightfinding was achieved using the 95 feet ($\alpha = 5.9^\circ$) dipole stack and a third stack at 45 feet ($\alpha = 12.5^\circ$).

All the measurements were taken using the same goniometer, the feeders from the various antennae elements being selected by the operator, using

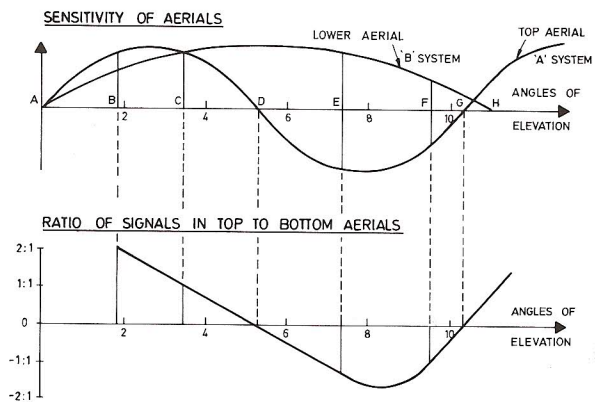

Fig. 5. Signals on height-finding dipoles, and their ratio

buttons operating a remote, motorized set of change-over switches.

Counting of aircraft in close formation (raid strength) relied on the skill of the operator who, when experienced, was able to make an assessment by observing the 'beat' rate of the composite echoes. To assist in this assessment, the transmitted pulse could be momentarily shortened to 6 microseconds (from 20 microseconds) by a push button on the console, the shorter pulse improving the range resolution by about 3:1.

It should be mentioned at this point that the great success of CH was due in no small measure to the incredible acquired skill of experienced operators, particularly the WAAFS (Women's Auxiliary Air Force). Signals at extreme ranges, well below 'noise' level, were detected and tracked.

The mechanism by which this was achieved is still not fully understood but believed to be due to an unconscious form of pattern recognition within the noise structure, somewhat analogous to the 'cocktail party' effect. Also, unlike scanning (searchlight) radars, CH, being a 'floodlit' system, provided update at p.r.f. rate with a corresponding integration gain when using a CRT with a long persistence phosphor. Figure 6 illustrates typical performance achieved by experienced operators on an average size bomber such as the Heinkel 111.

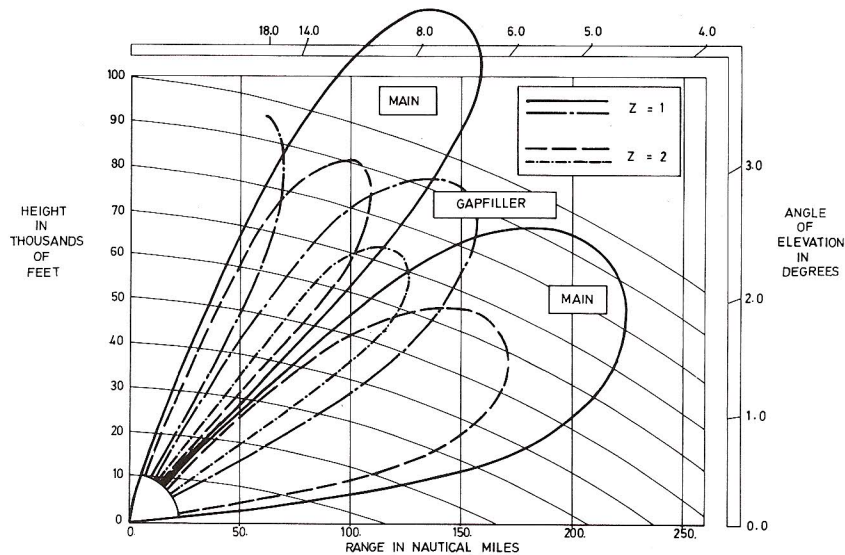

Fig. 6. Typical CH performance diagram

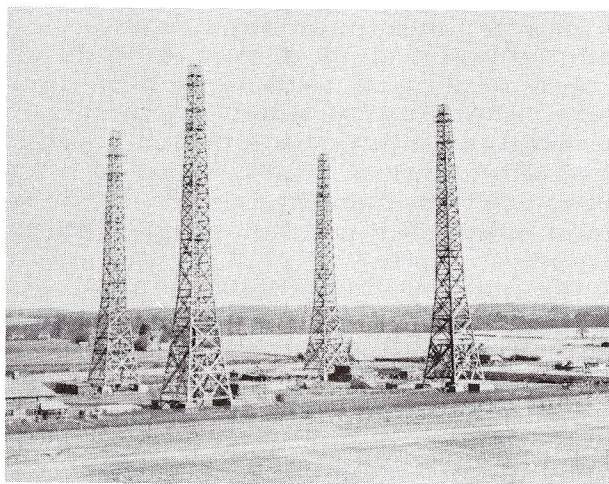

Fig. 7. East Coast CH receiver towers

RECEIVER ANTENNAE

Wooden towers, rather than steel, were used to avoid influencing the balance and symmetry of the receiver dipole stacks by the proximity of any metallic parts. The towers, 240 feet high with servicing platforms placed at regular intervals and accessed by a central ladder arrangement, are shown in figure 7.

There were three discrete antenna stacks spaced one above the other, identified as the 'A' system at a mean height of 215 feet, the 'B' system at 95 feet and the 'C' system at 45 feet, see figure 8.

The 'A' and 'B' systems were identical, each consisting of two sets of centre-fed horizontal crossed-dipoles, vertically stacked by a half-wavelength, figure 8. The dipoles were aligned to look N-S, and E-W. The N-S dipoles were designated 'X' and the E-W dipoles designated 'Y'. On the N-side of the X dipoles and the W-side of the Y dipoles, at a spacing of quarter wavelength were placed centre-switched reflectors. With the centre of the reflectors open, the polar diagram of the dipole stack was simply a 'figure

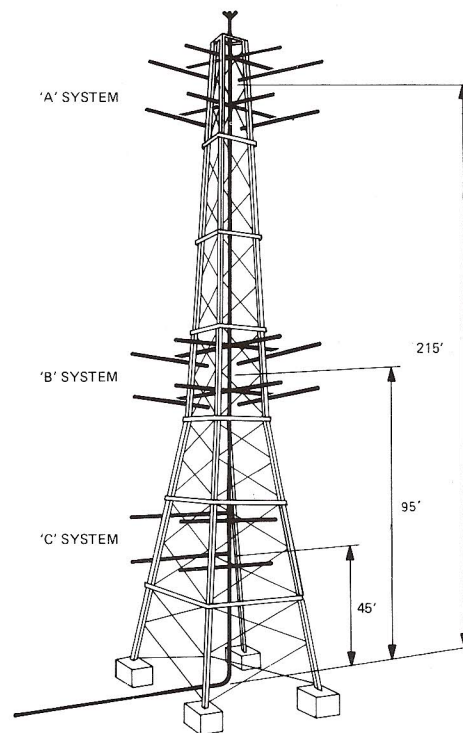

Fig. 8. Dipole arrays on a receiver tower

of eight', the reflectors having no effect. When closed, the reflectors were effective and the polar diagram was changed to a cardioid pattern increasing the signal strength in the E or S direction by some 3 db whilst reducing the W and N signals. These switches were relay operated and controlled by the operator at the console for 'sensing', as previously described.

The 'C' system at 45 feet was simply a stack of two single dipoles with non-switched reflectors. They were used only for heightfinding when the system

was operating in the gapfiller mode and played no part in direction finding.

As stated earlier, it was originally intended that each station should have the choice of any one of four allocated frequencies as an anti-jamming measure; it was intended, therefore, that each mast should carry a set of dipole stacks which had been carefully phased and calibrated for one specific frequency. This plan was later abandoned.

To preserve the electrical symmetry and low cross-talk between elements necessary for accurate direction and heightfinding, great care had to be taken in the bonding and alignment of the feeders connecting the dipoles to the remote goniometer and receiver system. Low loss, 72 ohm, solid copper cables pressurized with dry air to keep out moisture, were used as feeders. Phasing of the X and Y elements was achieved by inserting finely trimmed short lengths of flexible 72 ohm twin 'television' cable (BL7) between the co-axials and the goniometer, these links being folded up in a screened copper 'phasing' box and trimmed to length during the calibration process.

TRANSMITTER

The transmitter, designated T.3026, figures 9 and 10, was derived from a basic design by Metropolitan-Vickers for the short-wave station at Rugby. It was very unusual, probably unique at that time, in that it used continuously evacuated, demountable tetrodes as the output and driver stages, figure 11. Originally intended for c.w., the design was extensively modified to allow operation in a pulse mode at a very high peak power and low duty cycle (5×10^{-4}). It was

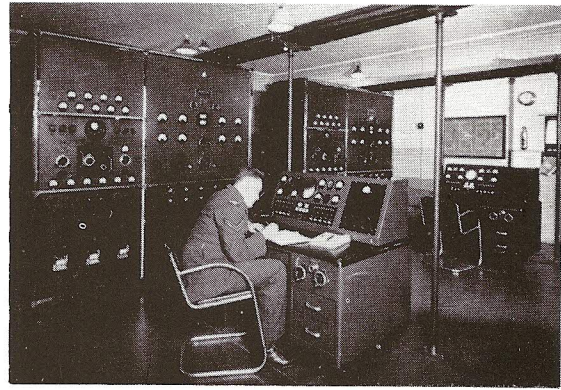

Fig. 9. East Coast CH transmitter room

also required to have the capability of being switched to any one of four spot frequencies in the band 20-50 MHz within 15 seconds to meet the four frequency concept of the original anti-jamming plan. The specification for pulse shape and stability was very stringent for those days; an r.f. pulse of 300 kW was completely outside the transmitter designers' experience. An additional requirement was that during the quiescent or interpulse period, the power radiated from the transmitter was not to exceed a few microwatts to avoid masking the nearby, highly sensitive receiver during the 'listening' period following the pulse.

Many ingenious ideas were tried in an endeavour to generate an r.f. pulse with fast leading and trailing edges and a minimum of c.w. breakthrough during

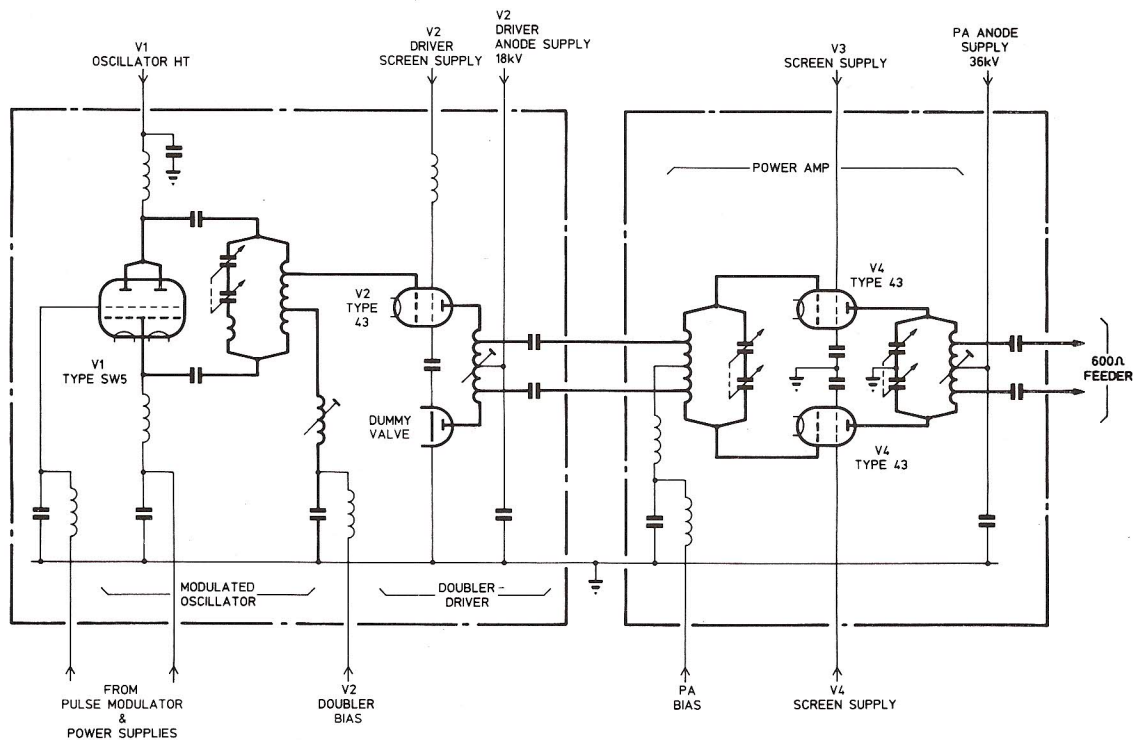

Fig. 10. Simplified circuit diagram of CH transmitter

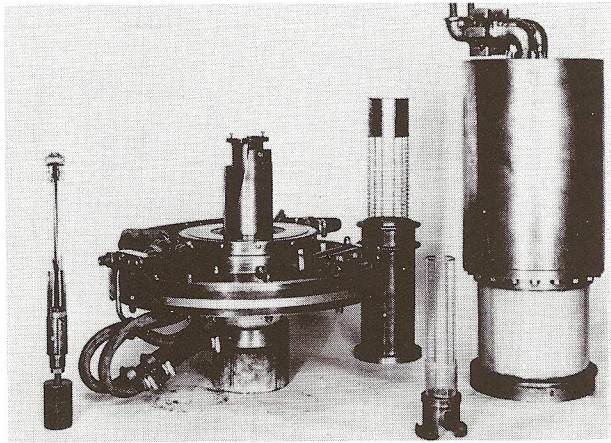

Fig. 11. Components of demountable valve type 43

the interpulse period together with very low intra-pulse FM. The final solution used a biased-off tetrode coupled as a modified Hartley oscillator tuned to half the station frequency and gated by a fast, positive-going pulse applied simultaneously to both control and screen grids. The gating, or modulating, pulse, was generated by a pair of mercury vapour thyratrons associated with a somewhat complicated timing and trigger circuit.

The pulse oscillator was coupled to a balanced class 'C' frequency doubler-driver stage consisting of a single power tetrode and a 'dummy' valve of equivalent capacity to provide a symmetrical, balanced output.

The output stage consisted of a pair of push-pull, high power tetrodes operating in class 'C' driven by the balanced output from the frequency doubler stage. The final output was fed via Pyrex d.c. blocking capacitors and 600 ohm open wire feeder to the antenna system.

Frequency selection was achieved by remote control of a motorized, multi-pole rotary switch which selected the appropriate pre-set tuned circuits. The tetrodes used a tungsten filament operating at 18 V/140 A. In its final form, the transmitter worked with around 35 kV on the anodes of the output stage and delivered a peak r.f. pulse power of approx 750 kW.

The water-cooled power tetrodes Type 43, figure 11, were of particular interest, being demountable to permit replacement of the filament, control grid and screen grid. A vacuum plant using a two stage oil-diffusion pump backed up by a rotary pump continuously evacuated the system. The state of the vacuum was monitored by Pirani gauges which controlled the operation of the plant and provided the interlock should the gas pressure rise above the permitted safety level.

The tetrodes were cooled by distilled water pumped round a closed circuit heat exchanger, the water being delivered to the tetrode anodes by coiled rubber tubes wound as chokes to prevent r.f. leakage.

When a tetrode was let down to air to replace an electrode, usually the filament, the tube had to be pumped down to a hard vacuum. To reduce the time

taken to reach correct operating pressure, the tetrode was 'conditioned' by applying raw a.c. to the electrodes, whilst the anode was held at a steady d.c. potential. This process caused the electrodes to be 'bombarded' and accelerated the emission of occluded gases, which were then drawn off by the vacuum pumps. The conditioning process was carried out with the tetrode in-situ, the additional components and control arrangements being incorporated in the basic transmitter design.

The transmitter was triggered by incoming positive pulses derived from the timing circuit in the receiver, which also generated the command signal to reduce the pulse length from 20 μ s to 6 μ s.

RECEIVER AND DISPLAY UNIT

The receivers were designed and manufactured by A. C. Cossor Ltd. to a TRE specification. As the war progressed, many modifications, improvements and additions were made to the original design, although the basic principles briefly described here remained virtually unchanged, figure 12. Figure 13 shows a general view of the receiver and display console, while figure 14 shows the team of operators at work.

The incoming co-axial cables from the receiver masts were fed via the 'phasing box' and motorized selector unit previously described, to the goniometer stator coils. In accordance with the original four frequency plan, there were actually four gonios each dedicated and calibrated to a spot frequency and all mechanically linked to a single search knob. A wave-change switch routed the operational goniometer search coil to the input stage of a three-stage r.f. amplifier. To preserve symmetry and hence stability, the r.f. stages were arranged in a push-pull arrangement, with each stage housed in its own screened box. The input stage used a pair of special low noise, 'aligned-grid' pentodes known as EF8s, very advanced valves for that period.

A push-pull mixer using a pair of triode-hexodes with separate triode local oscillator, down-converted the signal to 2 MHz was fed via a buffer and a two stage interference rejection unit (IFRU) to a 5 stage, single-ended i.f. amplifier. A choice of 3 bandwidths: 500 kHz, 200 kHz and 50 kHz was available to the operator selectable by a lever above the display. The matched bandwidth was theoretically 50 kHz, but many operators preferred a wider, non-optimum bandwidth as an aid to pattern recognition and raid strength assessment.

However, in the presence of jamming, the narrow bandwidth was used. After full-wave detection, the video signal was passed via a pair of push-pull deflection amplifiers to the Y plates of the CRT.

An important feature of the design of the r.f., i.f. and video stages was the necessity of restoring full sensitivity, immediately after the incidence of an overloading signal which could 'paralyze' the amplifiers. Care in the choice of decoupling capacitors, impedance of power supplies and time constants in general, was essential.

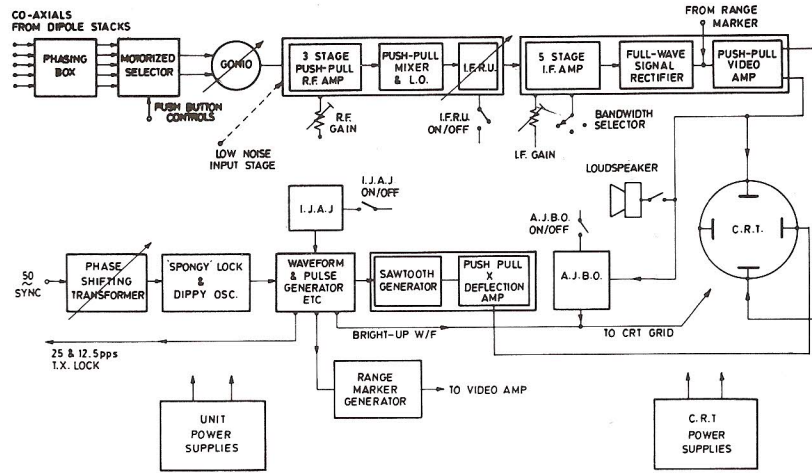

Fig. 12. Schematic diagram of receiver and display console

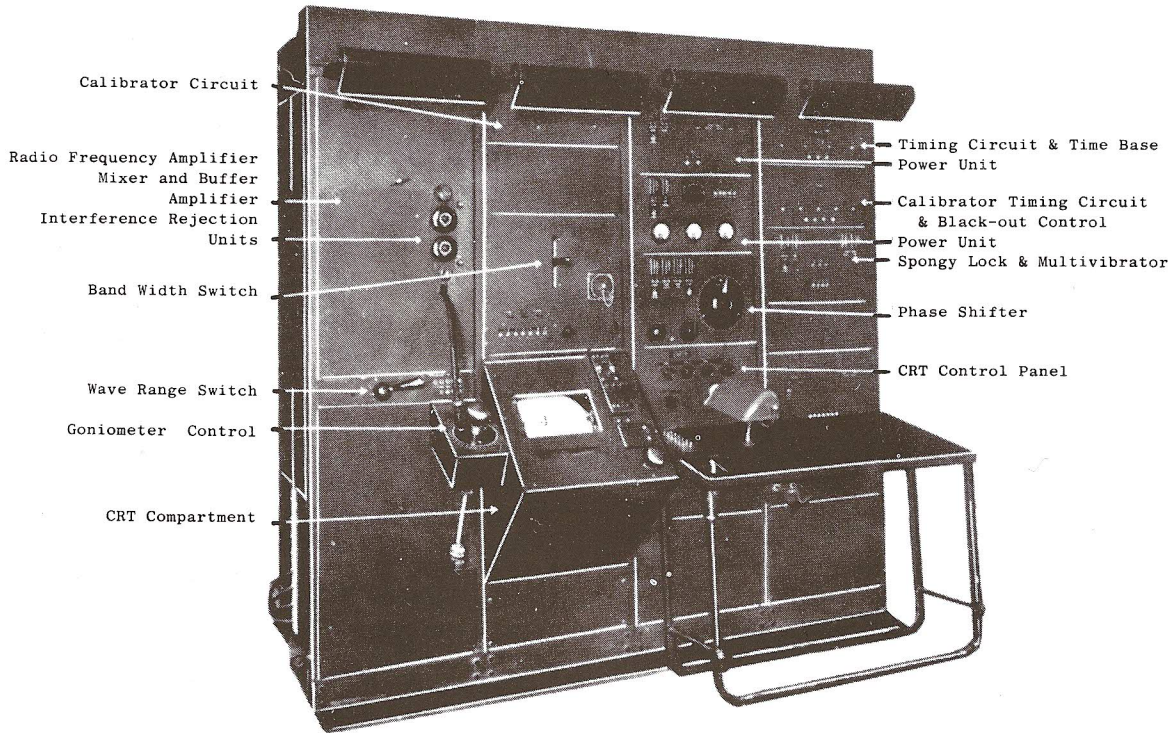

Fig. 13. East Coast receiver RF7

The very special care taken in the design of the focussing, deflection amplifiers, astigmatism correction and shift controls plus the high quality and resolution of the CRT, was a significant feature of the display unit and contributed in no small measure to the ability of skilled operators to detect and track targets of very low signal-to-noise ratios which might otherwise have been missed.

As mentioned earlier, the normal operating p.r.f. of the radar was 25 p.p.s., locked to a preset point on the mains 50 Hz waveform, allowing stations in the chain to operate without interfering with each other. The phase of a 50 Hz sine wave derived from a phase-shifting transformer, energized from the mains supply, was used to lock a Dippy oscillator operating

at 25 Hz. The locking was 'spongy' and worked in a manner similar to that of the flywheel time-base of a modern television set. The phase of the sine wave output of the phase-shifting transformer was continuously adjustable relative to the mains cycle, permitting a precise timing point to be chosen.

Each CH station was allocated a particular 'spot on the dial' from which it was not allowed to deviate without special permission from HQ! In conditions where severe 'scatter' from the ionosphere caused 'nth time around' clutter on the display, the operator would often, unofficially, move the dial in an endeavour to 'phase' it off the screen, thus often causing chaos further along the chain!

The 25 Hz sinewave output from the Dippy oscil-



Fig. 14. CH receiver room

was passed to a waveform generator and timing which produced the trigger for the transmitter, time-base and bright-up waveform for the display and the trigger for the calibrator unit. The calibrator generated a sequence of 10 mile marker pips which could be mixed in with signal, allowing the time-base to be accurately aligned to the range scale. The waveform generator also produced a 12.5 Hz timing pulse to suppress alternate trigger pulses to transmitter and display unit when, under bad atmospheric conditions, the operator selected the alternative p.r.f. of 12.5 p.p.s.

In the early years of the war, aircraft were manually tracked by reading off range from the calibrated scale of the display and the bearing from the bearing meter, and then tracked locally on a grid-plotted plotting board. The grid references were passed by the track-teller, via high quality land lines to the Filter Room. Groups of stations were each connected to the Filter Room each having its own dedicated plotter. The quality of the plots varied considerably, depending on the range and bearing of the target in relation to particular stations; the job of the plotters to sort out, or 'filter', the sometimes conflicting information and endeavour to establish a true track. New plots were assigned an 'X' prefix until positively identified and then allocated an 'H' or 'F' prefix for hostile or friendly. The

Filter Rooms were linked to the Fighter Control networks (GCI's, Sector Control, etc.) for appropriate action.

At a later stage, manual plotting was superseded by automatic plotting, using an electro-mechanical calculator, a 'fruit machine', figure 15, into which the various corrections resulting from calibration were programmed.

As the war progressed, many improvements were made to the equipment and to the reporting procedure to reduce the time taken to pass information to the various control centres at times when there were many raids in progress. For example, modifications to the receiver console were made to enable the operator after "D/F ing" the target and moving a cursor along the time-base to correspond to the target range, simply to press buttons for the data to be passed directly and automatically to the control centre.

Many ingenious devices, including optical converters, and calculators, too numerous to describe here, were introduced in the latter stages of the war which made the Chain Home system extremely efficient and reliable.

ECCM DEVICES

There were a number of ingenious anti-interference/

anti-jamming devices available to the operator. Perhaps the most significant was the use of a double phosphor CRT using a long 'afterglow' material (zinc cadmium sulphide) overlaid by an active blue phosphor (zinc sulphide). The 'flash' of the blue phosphor excited the long afterglow layer, leaving a yellowish image which could be viewed through a yellow filter whilst suppressing the blue flash, the theory being that enemy jamming, interference and the noisy background, being unsynchronized and of a transitory nature, would not build up a long afterglow image and would not be visible through the yellow filter. This system worked very well.

The IFRU, referred to earlier, was a pair of narrow-band notch filters, in series, which could be independently tuned within the i.f. pass-band to reject CW interference.

To counter the effect of 'spoofer' techniques, which enabled jammers to lock-on to the transmitted pulse and return a delayed pulse or sequence of pulses creating false targets, the station p.r.f. was intentionally 'jittered' in a random manner; false targets could then be easily identified as they would appear to jitter on the screen whilst true targets would appear stationary. This device was known as the Intentional Jitter Anti-Jamming Unit (IJAJ). Another device was the Anti-Jamming Black-Out unit (AJBO) which fed a portion of the video signal via a thresholding circuit with appropriate time constant to the grid of the CRT, 'blacking out' unsynchronized interference. A loudspeaker was also provided to assist the operator in identifying the nature of the interference or jamming by listening to the sound of the video signals.

It is worth mentioning at this point that the accuracy of the goniometer method of D/F was earlier thought likely to be inadequate especially in a heavy jamming environment. An alternative scheme, known as the 'Chapman' method (after the inventor, Corporal Chapman) using a system of range cuts to fix the target position, was proposed. One station would display echoes from its own transmitter plus echoes from the transmitter of an adjacent station on a second display. The operator had to swing his goniometer and note the two echoes, one on each CRT, which attained minima at the same goniometer setting to resolve ambiguity. The position of the target giving rise to the two echoes could then be found by range cuts, the goniometer playing no part in the position fixing. To prevent jitter between the two sources of signals, both locked to the grid system, the 'spongy-lock' method of synchronization mentioned earlier was adopted. In the event, the goniometer method of D/F, after careful calibration, was found to give sufficient accuracy for all practical purposes and the Chapman method was abandoned.

THE 'BIGGIN HILL EXPERIMENT'

Much has been written, and rightly so, of the 'Davenport Experiment' of 1935. Few people will know of an equally important experiment which took place between 1936 and 1937. At the instigation of

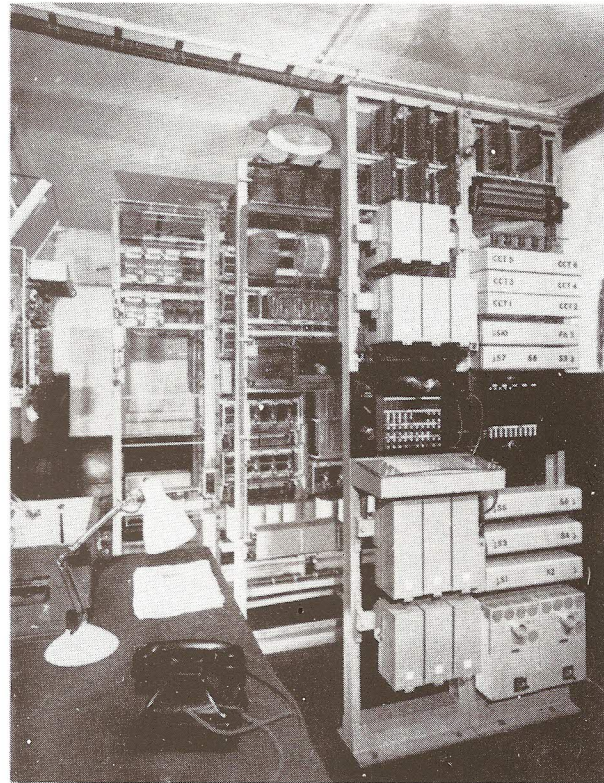

Fig. 15. CH electro-mechanical calculator

Henry Tizard, with typical foresight, a series of trials was carried out to establish an operational procedure for interception of hostile aircraft by control from the ground.

It was all very well having the ability to detect and track aircraft from the ground, but how best to use and act on this information? The efficient and successful procedure that was ready for action in 1939 was the direct consequence of a long series of mock interceptions by fighters (Gloster Gauntlets) from the air base at Biggin Hill controlled by R/T from the ground using filtered plots from the South East Coast CH stations. This exercise came to be known as the 'Biggin Hill Experiment'. For details of these historic and vital experiments the interested reader is referred to the biography of Henry Tizard by Ronald Clark.

'BIG BEN'

CH played a vital part towards the end of World War 2 in tracking V2 (A4) rockets launched from occupied Europe towards London and the southern counties. The problem was to detect rockets soon after launch so that the likely point of impact could be estimated and early warning given. Additionally, the point of launch could be pin-pointed to enable Mosquitoes of Bomber Command to make a precision attack on the launching site. A system of simultaneous range cuts from five stations: Bawdsey, Gt. Bromley, High St, Dunkirk and Swingate (Dover) enabled the trajectory to be plotted as the rockets passed through the vertical lobes of each

station, with sufficient accuracy to fulfill both these requirements.

The system was quite complex and relied on the integrity of the communication links and the high performance of the CH stations involved. The CH wavelength was most favourable for detection of the rocket which behaved roughly as a quarter-wave dipole with a very good response and provided detection ranges in excess of one hundred miles. The system was code-named 'Big Ben',

CONCLUSION

CH was a remarkable achievement when set against the desperation of the times; it seems nothing short of miraculous that following a simple proving experiment at Daventry, the Home Chain was planned, developed, engineered, manufactured and installed just in time to meet the onslaught of the Luftwaffe. There can be no shadow of doubt that without CH, we would not have survived. We should be eternally thankful for men of the calibre of Henry Tizard, Watson-Watt, Arnold Wilkins, E. G. Bowen and many others who had the vision, courage, ability and above all the faith, to forge a system of the magnitude and complexity of the Home Chain in the little time available.

It was, indeed, a close run thing!

BIBLIOGRAPHY

- 1 Journal of the IEE, 93, Pt. IIIA, (Radiolocation) 1946.
- 2 TAYLOR, D., 'Introduction to Radar and Radar Techniques', Newnes, London, 1966.
- 3 WOOD, D. and DEMPSTER, N., 'The Narrow Margin', Arrow Books, 1961.
- 4 CLARK, R. W., 'Tizard', Methuen & Co. Ltd., 1965.

APPENDIX I. List of 'East Coast Type' CH Stations

1. Ventnor	Isle of Wight
2. Poling	Sussex
3. Pevensey	Sussex
4. Rye	Sussex
5. Swingate	Kent
6. Dunkirk	Kent
7. Canewdon	Essex
8. Gt. Bromley	Essex
9. Bawdsey	Suffolk
10. High St. Darsham	Suffolk
11. Stoke Holy Cross	Norfolk
12. West Beckham	Norfolk
13. Stenigot	Lincolnshire
14. Staxton Wold	Yorkshire
15. Danby Beacon	Yorkshire
16. Ottercops Moss	Northumberland
17. Drone Hill	Scotland
18. Douglas Wood	Scotland
19. School Hill	Scotland
20. Hillhead	Scotland
21. Netherbutton	Orkney

APPENDIX 2. Extract from Siting Specification for CH - 'RDF' Stations (circa 1936)

A site well back from the coast, with a smooth slope between it and the sea, gave good height-finding and good range-finding — there was a rule by which one knew how far inland it was worth going to get height above sea level. But irregularities of ground were inevitable and these distorted the height-finding properties of the equipment and gave 'permanent echoes' similar to those produced from large aircraft. The chosen sites had also to be accessible to heavy engineering works; to have soil suitable for carrying 360 foot steel masts — they had to be convenient for electrical supplies, secure against sea bombardment, inconspicuous from the air and it was furthermore essential that they should not '*gravely interfere with grouse shooting*'.

Bruce Neale worked on a variety of radar systems during the war, including CH, GCI and OBOE. He joined Marconi in 1952 as a radar development engineer, and played a major part in the development of numerous radar systems. He retired from the post of Chief Engineer, Airspace Control Division in February, 1985, and was a technical consultant to Marconi Radar Systems Limited, for several years. Bruce died after a long illness on 7th March 1990.

THE GEC JOURNAL OF RESEARCH, (INCORPORATING THE MARCONI REVIEW) is published quarterly by The General Electric Company, p.l.c. All enquiries should be addressed to the Editor, GEC Journal of Research, GEC Research Laboratories, Marconi Research Centre, Great Baddow, Chelmsford, Essex, CM2 8HN, UK. Telex: 995016. Telephone: 0245 73331.

© 1985 The General Electric Company, p.l.c.